



AUDIOVOX®
ELECTRONICS CORP.

Operation Manual

PORTABLE DVD PLAYER

Model: D705

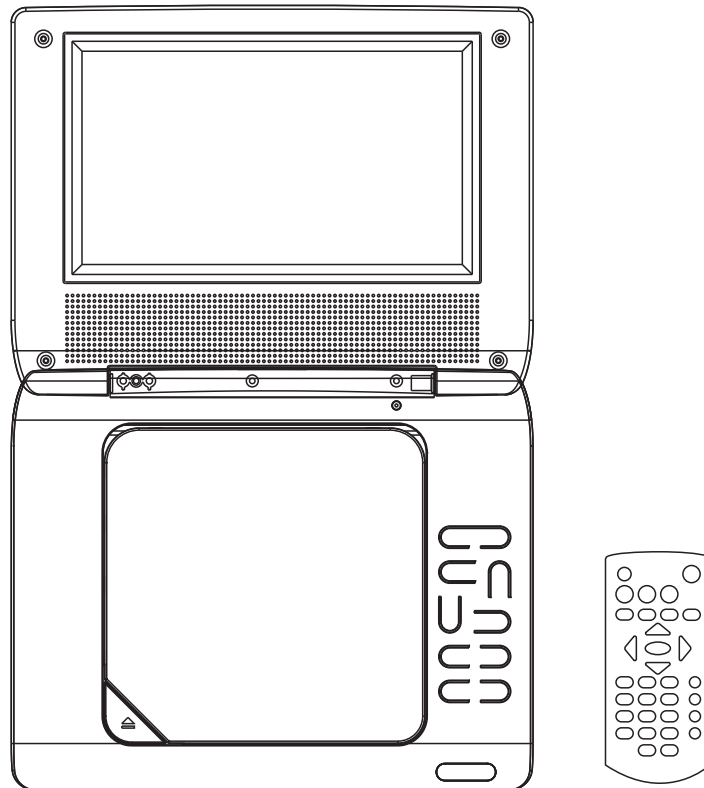

READ THESE INSTRUCTIONS THOROUGHLY PRIOR TO CONNECTING AND OPERATING YOUR DVD PLAYER.
PLEASE RETAIN THIS MANUAL IN CASE YOU NEED IT FOR FUTURE REFERENCE.
THE ILLUSTRATIONS AND GRAPHICS IN THE MANUAL ARE FOR REFERENCE ONLY AND SUBJECT TO CHANGE WITHOUT NOTICE.

This page intentionally left blank.

Notice:

This Product incorporates copyright protection technology that is protected by method claims of certain U.S. Patents and other intellectual property rights owned by Macrovision Corporation and other rights owners. Use of this copyright protection technology must be authorized by Macrovision Corporation, and is intended for home and other limited viewing uses only unless otherwise authorized by Macrovision Corporation. Reverse engineering or disassembly is prohibited.

Notice:

An LCD panel and/or video monitor may be installed in a motor vehicle and visible to the driver if the LCD panel or video monitor is used for vehicle information, system control, rear or side observation or navigation. If the LCD panel or video monitor is used for television reception, video or DVD play, the LCD panel or video monitor must be installed so that these features will only function when the vehicle is in "park" or when the vehicle's parking brake is applied.

An LCD panel or video monitor used for television reception, video or DVD play that operates when the vehicle is in gear or when the parking brake is not applied must be installed to the rear of the driver's seat where it will not be visible, directly or indirectly, to the operator of the motor vehicle.

Notice:

The D705 DVD Player contains a built-in battery. To obtain the best performance from your DVD Player please refer to the following battery care instructions:

CHARGING THE D705

When charging the DVD Player the power switch should be set to off. The battery can only charge when the DVD Player is off. The DVD Player can be charged using the AC to DC adaptor or the vehicle DC power adaptor. When the battery is fully discharged the unit will require approximately 2~3 hours to fully recharge the battery. The battery must be charged at least 8 hours prior to first use.

While the unit is charging, the LED indicator will be on. Once the unit is fully charged the LED will be off. When the battery is fully charged, the unit will play for approximately 2 hours. You should charge the unit once a month to ensure that the unit will be operational for 2 hours.

Do not charge the DVD Player in the vehicle when the vehicle is not running.

Note: If you do not plan to use the battery for an extended period of time (one week or longer), we recommend that you fully charge the battery. For longer periods of storage, please recharge the battery at least once every two months to maintain the battery in optimum condition.

Precautions Related to Battery Recharge:

1. Once the battery is fully discharged, immediately recharge the battery (regardless of whether you plan to use the battery or not) in order to maximize battery life.
2. Recharge efficiency will degrade when temperatures drop below 50°F (10°C) or exceed 95°F(35°C).

Introduction

Thank you for selecting the D705 portable DVD Player. The main features include a 7" Screen (16:9 Aspect Ratio) Liquid Crystal Display (LCD) monitor and a DVD Player. The unit applies the latest state-of-the-art electronics and is designed for use in hotels, offices, homes or vehicles. The unit is constructed to provide years of reliable, trouble-free service, is compact so that you can take it with you anywhere, and is designed for quick and easy installation. Please read the entire instruction manual supplied with this product prior to operation. The documentation will assist you in installing the system properly to obtain the best equipment performance. Please save this manual for later use.

Cautions and Warnings

1. Placement

To prevent fire or electric shock, do not expose this appliance to rain or moisture. Do not place the set on an unstable cart, stand, tripod, bracket or table to prevent it from falling. Keep the unit away from strong magnets, heat sources, direct sunlight, or excessive dust. If the unit is brought directly from a cold to a warm location, moisture may condense inside the unit. When you move it from a cold to a warm location, wait for about one hour before operating the unit, or remove the disc and leave the unit turned on until the moisture evaporates.

2. Installation

Ensure that the D705 is installed and used in accordance with the instructions and illustrations provided in this manual.

3. Objects and Liquids

Do not push objects of any kind into the unit through openings; do not spill, splash or spray liquid of any kind on or in the system (this may result in a fire or electric shock). Do not place anything heavy on the unit. Do not place any open flame sources, such as lighted candles, on the unit.

4. Ventilation

To ensure proper ventilation and proper operation, never cover or block the slots and openings with a cloth or other material.

5. Disassembly

Do not attempt to disassemble the case or replace the battery. There is a risk of electric shock and/or exposure to Laser Radiation. Contact qualified service personnel if your system is in need of repair.

6. Cleaning Unit

When cleaning, make sure the system is unplugged from the power source. Do not use liquid cleaners or aerosol cleaners. Use a cloth lightly dampened with water for cleaning the exterior of the DVD Player system only.

7. Disc

Do not use irregularly shaped discs such as heart or star-shaped discs as they may cause the unit to malfunction. Do not stick paper, tape or glue on the disc. Do not expose the disc to direct sunlight or heat sources such as hot air ducts. Do not touch the surface of the disc. Handle the disc by its edge. Clean the disc by wiping the disc from the center out with a cleaning cloth. Remove the disc from the unit and store it in its case after playing. Some playback operations of discs may be intentionally fixed by software producers. Since this unit plays discs according to the disc contents the software producers designed, some playback features may not be available. Also, refer to the instructions supplied with the discs.

Regional Coding

Both the DVD Player and disc are coded by region. These regional codes must match in order for the disc to play. If the codes don't match, the disc won't play. This unit's code is region 1. DVDs with other regional codes cannot be played in this unit.

Contents

1. 1 x 7" LCD Monitor and DVD Player With Built-In Battery
2. 1 x AC to DC Adapter
3. 1 x Remote Control with Batteries (2 X 1.5 V, Size AAA)
4. 1 x Instruction Manual
5. 1 x Audio/Video Cable
6. 1 x DC Power Adapter

OVERVIEW OF THE DVD PLAYER:

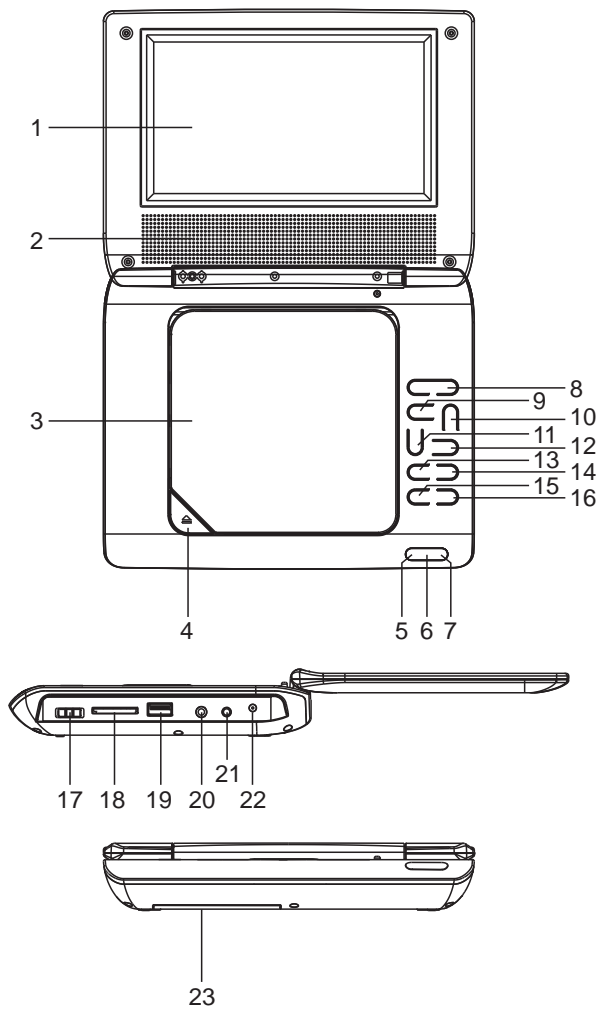

1. LCD SCREEN
2. SPEAKERS
3. DISC COVER
4. DISC COVER OPEN BUTTON
5. CHARGE INDICATOR
6. REMOTE CONTROL SENSOR
7. POWER INDICATOR
8. OK BUTTON
9. NAVIGATION UP (▲) BUTTON
10. VOLUME + & NAVIGATION RIGHT (▶) BUTTON
11. VOLUME - & NAVIGATION LEFT (◀) BUTTON
12. NAVIGATION DOWN (▼) BUTTON
13. PREVIOUS (◀◀) & FAST BACKWARD (◀◀) BUTTON
14. NEXT (▶▶) & FAST FORWARD (▶▶) BUTTON
15. STOP (■) & SOURCE BUTTON
16. PLAY/PAUSE BUTTON (▶/||)
17. POWER ON/OFF SWITCH
18. SD/MMC CARD SLOT
19. USB PORT
20. PHONES JACK
21. AUDIO/VIDEO OUT JACK
22. DC IN JACK

* Rating label is located at the bottom of the unit.

REMOTE CONTROL UNIT

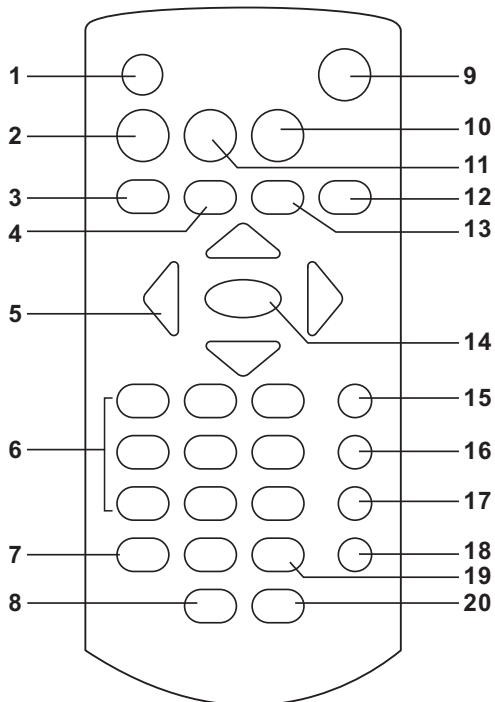

1. SCREEN ON/OFF BUTTON
2. TITLE BUTTON
3. PREVIOUS (◀◀) & FAST BACKWARD (◀◀) BUTTON
4. NEXT (▶▶) & FAST FORWARD (▶▶) BUTTON
5. NAVIGATION (◀, ▲, ▼, ▶) BUTTONS
6. NUMERIC BUTTONS
7. PROGRAM/ANGLE BUTTON
8. VOLUME - BUTTON
9. MUTE BUTTON
10. SETUP BUTTON
11. MENU BUTTON
12. DISPLAY BUTTON
13. STOP (■) & SOURCE BUTTON
14. OK (PLAY/PAUSE) (▶/||) BUTTON
15. SUBTITLE BUTTON
16. AUDIO BUTTON
17. SEARCH BUTTON
18. REPEAT BUTTON
19. ZOOM/SLOW BUTTON
20. VOLUME + BUTTON

CONNECTING THE DVD PLAYER TO OTHER DEVICES

When connecting the DVD Player to a TV, ensure that the DVD Player and other devices (TV set and/or amplifier) to be connected to the DVD player are set to OFF.

Do not block ventilation holes of any of the equipment and arrange them so that air can circulate freely.

Read through the instructions before connecting other equipment.

Observe the color coding when connecting audio and video cables, for instance connect yellow plug to the yellow jack, the red plug to the red jack and so on. If the A/V connected cable is only supplied, please link one end of the A/V connected cable with A/V cable according to the color coding, and connect the other end of the A/V connected cable to the unit, finally connect the AV cable with TV set.

Note:

During DVD play, the TV volume may be at a lower level than during TV broadcasts, etc. If this is the case, adjust the volume to the desired level.

If the DVD/CD player is connected to the TV through a video cassette recorder, the picture may not be played back normally with some DVDs. If this is the case, do not connect the player via the VCR.

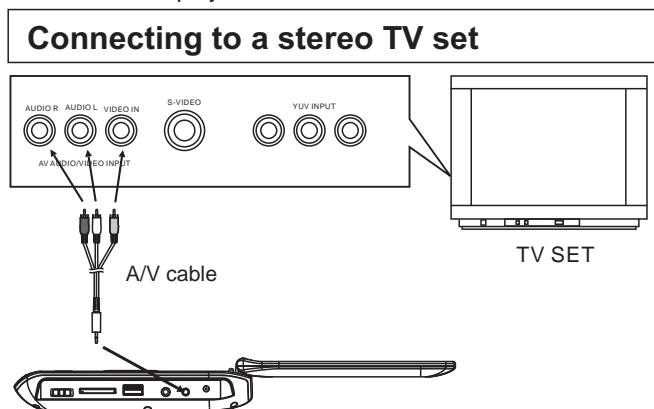

After connecting the DVD player to another device, plug the AC ADAPTER to an applicable wall outlet and turn on the player.

CONNECTING TO THE VEHICLE DC ADAPTOR

The vehicle power adaptor is designed for use with vehicles that have a 12V, negative ground electrical system.

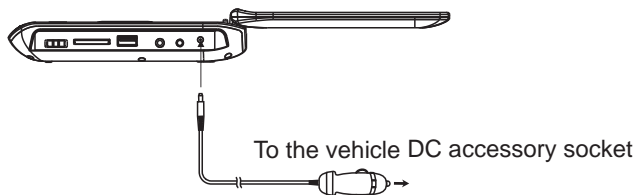

CAUTIONS:

- Use the unit only with the recommended vehicle power adaptor, use with other vehicle powers adaptor could damage the unit.
- The recommended vehicle power adaptor is for use with this unit only. Do not use it with other equipment.
- In the interests of road traffic safety, do not operate the unit or view video software while driving a vehicle.
- Make sure the unit is fastened securely to prevent it from moving around the vehicle in an accident.

- After use, disconnect the vehicle power adaptor from both the unit and vehicle DC accessory socket.

FUSE REPLACEMENT

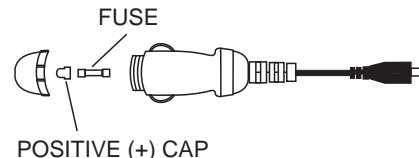

Note: Don't throw out the positive (+) cap when replacing the fuse.

OPERATION

PREPARATION

Power on the TV set and select video input mode.

Power on the audio system which is connected to the player

GETTING STARTED

1. Slide the POWER ON/OFF switch to turn on the player.
2. Press the disc cover OPEN key to open the disc cover, and then place the disc onto the disc tray.
3. Close the disc tray and the playback starts automatically.
4. When the DVD menu screen appears, use the navigation buttons to select a preferred chapter number, then press the OK (PLAY/PAUSE) (▶/||) button to start playback.

ADJUSTING THE VOLUME

Press the VOLUME +/- button on the remote or press and hold these two buttons on the unit to increase or reduce the volume level.

MUTE

During playback, press the MUTE button to shut off the audio output of the unit. Press it again to resume normal play.

SKIP AHEAD OR BACK

Press the PREVIOUS (◀◀) or NEXT (▶▶) button once during play to skip a chapter (DVD) or a track (CD) ahead or backwards.

FAST FORWARD OR BACKWARD

During playback, press and hold the FAST FORWARD (▶▶) or FAST BACKWARD (◀◀) button several times to scan the disc forward or backward at X2, X4, X8, X16, X32 normal speed. Press the OK (PLAY/PAUSE) (▶/||) button to resume normal play.

STOP PLAYBACK

Press the STOP (■) button during playback to stop playback. The player activates its resume function when STOP (■) is pressed in STOP mode. Press the PLAY button again, playback resumes at the point it stopped previously. Open the disc tray or press the STOP (■) button one more time to clear the resume function. Press and hold this button to make changes between DVD, CARD, and USB.

SLOW-MOTION PLAY (DVD)

Press and hold the ZOOM/SLOW button on the remote control during playback, the Disc will play at 1/2 normal speed. Each time this button is pressed, the play speed becomes slower at 1/4, 1/8, and 1/16 speed.

REPEAT

Press the REPEAT button during playback, it will repeat play one chapter/title or repeat all (for DVD disc), or repeat play a track or all tracks (CD), or repeat the sections between two specific points (A-B).

SEARCH FOR A SCENE

1. Press the SEARCH button several times during play to show different Search modes.
2. Input the desired number or time via the numeric buttons.
3. Press the OK (PLAY/PAUSE) (▶/||) button to confirm and the playback from the located scene starts.
4. The Search menu will automatically clear if no buttons are pressed on the remote control or unit.

ON SCREEN DISPLAY INFORMATION

When the player is in operation, press the DISPLAY button on the remote control to display title elapsed time, title remaining time, chapter elapsed time or chapter remaining time.

CHANGING AUDIO SOUNDTRACK LANGUAGE (DVD)

The audio soundtrack language can be changed to a different language from the one selected at the initial settings. This function is only available on discs which contain multiple audio soundtrack languages. Press the AUDIO button to change the sound track language during DVD disc play.
Note: When no soundtrack languages are recorded, the AUDIO button not operate.

CHANGING SUBTITLE LANGUAGE (DVD ONLY)

Press the SUBTITLE button during playback to display subtitle languages; the subtitle language shown on the screen will change each time the button is pressed. When the desired language appears, release the button to view the subtitle in that language.
Note: This function only works on the DVDs recorded with multi-language subtitles.

RETURN TO MAIN MENU AND PLAY THE TITLE

During playback, press MENU button to return to the root menu and press TITLE button to play the title.

PROGRAM PLAY (UP TO 20 MEMORIES)

1. Press PROGRAM during playback to display the program menu.
2. Select location(s) to be memorized via the navigation buttons and then enter desired Chapter and Title numbers via the numeric buttons.
Note: It is unnecessary to input the leading figure zero. If the Chapter and Title number is more than the number 10, press the unit digit key first and then another unit digit. To program another ten tracks, select the NEXT button. Up to 20 tracks can be programmed.
Example: Track 3, press "3"
Track 12, press "1" and then "2"
Track 21, press "2" and then "1"
3. To start programmed playback, scroll to START on the menu and then press the OK (PLAY/PAUSE) (▶/||) button.
4. To clear all programmed items, first press the PROGRAM button to enter the program menu, it will highlight STOP on the menu, press the OK (PLAY/PAUSE) (▶/||) button once to confirm, then EXIT on the menu will be highlighted. Press OK (PLAY/PAUSE) (▶/||) again to exit the program menu.

ZOOM PLAY

Press the ZOOM button continuously to zoom in the picture by 2, 3, and 4 times. Scroll to view the enlarged picture using the navigation buttons.

MULTI-ANGLE VIEWING (DVD ONLY)

Press and hold the ANGLE button during playback to select a desired angle to view the scene.
Note: Only the DVDs shot with multi-angle scenes have this function.

JPEG PLAYBACK

Picture slide shows begin automatically after a CD containing images is loaded into the DVD Player. JPEG images contained in the folders are displayed on the LCD screen. Use the navigation buttons to select the desired folder and then press OK (PLAY/PAUSE) (▶/||) button to confirm. The files in this folder are displayed and you can select your favorite pictures using the up/down navigation buttons and pressing OK (PLAY/PAUSE) (▶/||) button to start playback.

VIEWING JPEG FILES

1. PLAY MODES

Press the REPEAT button to change play mode. During playback, press the STOP (■) button to show folders/files in the disc.

2. SKIP TO NEXT/PREVIOUS PICTURE

Press the NEXT (▶▶) button to skip to the next picture or the PREVIOUS (◀◀) button return to the previous picture.

3. PICTURE ROTATIONS

Press the RIGHT (▶) and LEFT (◀) navigation buttons to rotate the picture clockwise and counterclockwise, respectively.

4. PICTURE FLIPS

Press the UP NAVIGATION (▲) button to flip the picture vertically.
Press the DOWN NAVIGATION (▼) button to flip the picture horizontally.

5. PICTURE ZOOM IN/OUT

Press the ZOOM button continuously, the picture zooms in and out. If the picture is enlarged, you may use the navigation buttons to view blocked parts of the picture.

SCREEN ON/OFF

During playback, press the SCREEN ON/OFF button to turn the LCD display on or off.

COLOR AND BRIGHTNESS ADJUSTMENT (FOR THE LCD SCREEN)

Press SCREEN ON/OFF button on the remote control to adjust the color intensity and brightness respectively via navigation left/right button.
Press and hold this button for a moment to turn the LCD display on or off.

EXTERNAL MEMORY MEDIA OPERATION (USB & SD/MMC CARD)

- To prepare the player for External Memory media operation:
1. Slide the POWER switch to the ON position.
 2. Plug a USB device containing audio/video files into the USB port or insert the SD/MMC card with the label side facing up into the card slot. The USB or the SD/MMC card will be detected and read after a few seconds. At the same time, the LCD screen will show all its folders.
 3. Press the NEXT (▶▶) or PREVIOUS (◀◀) button to skip ahead or backwards. Press the REPEAT button to change the play mode.

Note: Press and hold the STOP (■) button to change between the DVD, CARD, and USB inputs.

CAUTION: To avoid electronic static discharge, don't touch the USB port and card slot during playback.

INITIAL SETTINGS

Initial settings allow you to personalize the DVD Player settings to your preference. Once the initial settings are set, they are retained in the DVD Player until modified.

ADJUSTING INITIAL SETTINGS

1. Press the SETUP button.
2. Use the navigation buttons to select the item you want to modify. Use the navigation buttons to perform changes.
3. Press the OK (PLAY/PAUSE) (▶/||) button to confirm modifications.
4. Use the navigation buttons to switch to another setting on the main setting page.
5. Press the SETUP button to exit main setting page.

1. GENERAL SETUP

General Setup Page	
TV Display	Wide
LCD Mode	16:9
OSD Lang	ENG
Screen Saver	ON
Exit Setup	

1.1 TV DISPLAY - Used to select the TV output mode.

Options: Normal/Ps
Normal Lb
Wide

1.2 LCD MODE - Used to select the LCD mode.

Options: 4:3
16:9

1.3 OSD LANGUAGE - Used to select different On Screen Display languages.

Options: English
French
Spanish
Italian

1.4 SCREEN SAVER - When the DVD Player is not in used for several minutes, a running DVD logo will move across the LCD screen to protect the LCD screen.

Options: On: Screen saver is enabled.
Off: Screen saver is disabled.

1.5 EXIT SETUP - Used to exit the setup menu.

2. AUDIO SETUP

Audio Setup Page	
Downmix	
Exit Setup	

2.1 DOWNMIX

Options: Lt/Rt - Left/Right mix mode.
Stereo - Select this option if you don't have a 5.1 channel amplifier.

2.2 EXIT SETUP - Used to exit the setup menu.

3. VIDEO QUALITY SETUP

Video Setup Page	
Brightness	00
Contrast	00
Hue	00
Saturation	00
Exit Setup	

3.1 BRIGHTNESS - Adjusts the brightness of the screen.

3.2 CONTRAST - Adjusts the contrast of the screen.

3.3 HUE - Adjusts the hue of the screen.

3.4 SATURATION - Adjusts the saturation color level of the screen.

3.5 EXIT SETUP - Used to exit the setup menu.

4. SYSTEM SETUP

Preference Page	
TV Type	NTSC
Audio	ENG
Subtitle	ENG
Disc Menu	ENG
Parental Password	
Default	
Exit Setup	

Please follow the steps below to enter the System Page: First, power on the unit when the disc tray is empty or the disc door is opened, then press the SETUP button and enter the System Page by pressing the NAVIGATION buttons. Or during playback, press the STOP button twice, and then press the SETUP button to enter the system setup page.

4.1 TV TYPE - Used to select the TV type.

Options: PAL, Multi, and NTSC

4.2 AUDIO - Used to select the preferred audio language.

Options: English, French, German, Spanish, Portuguese, Italian, Dutch
(DVD only - needs disc software support)

4.3 SUBTITLE - Used to select preferred the subtitle language.

Options: English, French, German, Spanish, Portuguese, Italian, Dutch, Off

(DVD only - needs disc software support.)

4.4 DISC MENU - Used to select the preferred disc menu language.

Options: English, French, German, Spanish, Portuguese, Italian, Dutch

(DVD only - needs disc software support.)

4.5 PARENTAL - Used to select viewing rating levels of DVDs that contain rating levels

Options: Kid Safe, G, PG, PG-13, PGR, R, NC-17, Adult

(DVD only - needs disc software support.)

4.6 PASSWORD - Used to change the password.

Option: Change

Procedure to change the password:

1. Enter the old password in the Old Password row.
 2. Enter the new password in the New Password row.
 3. Enter the new password again in the Confirm Pwd row.
- You may reset the password if you forget the old password by using the default password: 3308

4.7 DEFAULT - Used to restore all settings to factory settings.

Option: Reset

4.8 EXIT SETUP - Used to exit the setup menu.

DISC HANDLING PRECAUTIONS

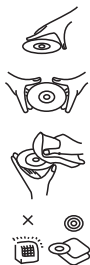

- Hold the disc by the edge so the surface will not be soiled with fingerprints. Fingerprints, dirt, and scratches can cause skipping and distortion.
- Do not write on the label side with a ball-point pen or other writing utensils.
- Do not apply benzine, thinner or other liquids that will damage the disc.
- Be careful not to drop or bend the disc.
- Install only one disc in the disc tray.
- Do not try to close the disc tray when the disc is not installed properly.
- Be sure to store the disc in its case when not in use.

TROUBLESHOOTING

If your DVD player does not seem to be functioning properly, check the items below before you contact Audiovox Tech Support.

Symptom	Check
Power does not turn on or suddenly turns off.	<ul style="list-style-type: none"> • Make sure the AC adapter is securely plugged into an AC outlet. • Turn the power off and then back on. • Battery may require charging if connected to a TV.
No picture or sound	<ul style="list-style-type: none"> • Check that the A/V cables are securely connected. • Check that the disc is a DVD, DVD-RW or AUDIO CD. • Do not use a disc that has scratches or dirt. • Check that the label-side of the disc is facing up. • The pick-up lens of the DVD player may be dirty. Contact the service center for lens cleaning. • Check that the TV channel is set to VIDEO or AV if viewing with a TV.
No picture	<ul style="list-style-type: none"> • Check that the LCD display is turned on.
No sound	<ul style="list-style-type: none"> • Check that the display panel is open. If it is closed, audio will not be output to the speakers. • Check the volume setting. If set to zero, turn up volume level. • Check that the headphones are plugged into the PHONES socket. Speakers cannot be used with the headphones.
No picture and sound	<ul style="list-style-type: none"> • Check that the AC Adapter is properly connected.
Distorted video or sound	<ul style="list-style-type: none"> • Use a disc without scratches or dents.

This page intentionally left blank.



AUDIOVOX®
ELECTRONICS CORP.

90 DAY LIMITED WARRANTY

Applies to Audiovox Video Products

AUDIOVOX ELECTRONICS CORP. (the Company) warrants to the original retail purchaser of this product that should this product or any part thereof, under normal use and conditions, be proven defective in material or workmanship within ninety (90) days from the date of original purchase, such defect(s) will be repaired or replaced with reconditioned product (at the Company's option) without charge for parts and repair labor. A game controller, if supplied, is similarly warranted for ninety (90) days.

To obtain repair or replacement within the terms of this Warranty, the product is to be delivered with proof of warranty coverage (e.g. dated bill of sale), specification of defect(s), transportation prepaid, to the Company at the address shown below.

This Warranty does not extend to the elimination of externally generated static or noise, to correction of antenna problems, to costs incurred for installation, removal or reinstallation of the product, or to damage to digital memory/media devices, gaming devices, discs, speakers, accessories, or electrical systems.

This Warranty does not apply to any product or part thereof which, in the opinion of the Company, has suffered or been damaged through alteration, improper installation, mishandling, misuse, neglect, accident, or by removal or defacement of the factory serial number/bar code label(s). THE EXTENT OF THE COMPANY'S LIABILITY UNDER THIS WARRANTY IS LIMITED TO THE REPAIR OR REPLACEMENT PROVIDED ABOVE AND, IN NO EVENT, SHALL THE COMPANY'S LIABILITY EXCEED THE PURCHASE PRICE PAID BY PURCHASER FOR THE PRODUCT.

This Warranty is in lieu of all other express warranties or liabilities. ANY IMPLIED WARRANTIES, INCLUDING ANY IMPLIED WARRANTY OF MERCHANTABILITY, SHALL BE LIMITED TO THE DURATION OF THIS WRITTEN WARRANTY. ANY ACTION FOR BREACH OF ANY WARRANTY HEREUNDER INCLUDING ANY IMPLIED WARRANTY OF MERCHANTABILITY MUST BE BROUGHT WITHIN A PERIOD OF 12 MONTHS FROM DATE OF ORIGINAL PURCHASE. IN NO CASE SHALL THE COMPANY BE LIABLE FOR ANY CONSEQUENTIAL OR INCIDENTAL DAMAGES FOR BREACH OF THIS OR ANY OTHER WARRANTY. No person or representative is authorized to assume for the Company any liability other than expressed herein in connection with the sale of this product.

Some states do not allow limitations on how long an implied warranty lasts or the exclusion or limitation of incidental or consequential damage so the above limitations or exclusions may not apply to you. This Warranty gives you specific legal rights and you may also have other rights which vary from state to state.

Audiovox Electronics Corporation, 150 Marcus Blvd., Hauppauge, New York 11788 • 1-800-645-4994

128-5556G



For Customer Service
Visit Our Website At
www.audiovox.com
Product Information, Photos,
FAQ's Owner's Manuals